



RUBINETTERIE

F.lli Frattini[®]

ISTRUZIONI DI MONTAGGIO ESTETICHE INCASSO 98018

INSTALLATION INSTRUCTIONS FOR EXTERNAL PARTS FOR ITEM 98018

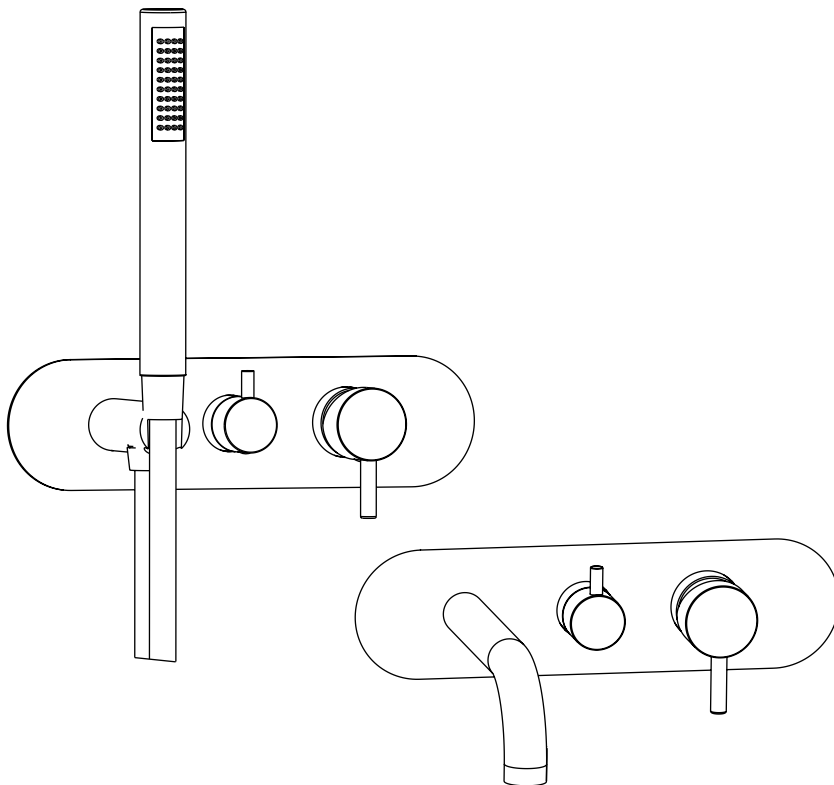

INSTALLAZIONE ESTETICHE VASCA INCASSO

Installation
Installation
Montaje
Einbau

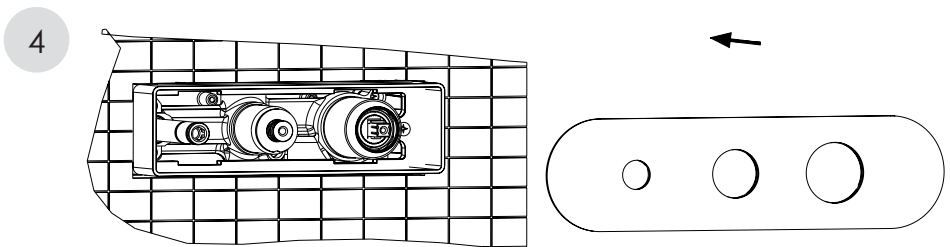
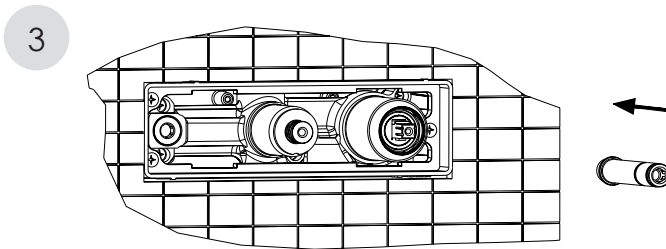
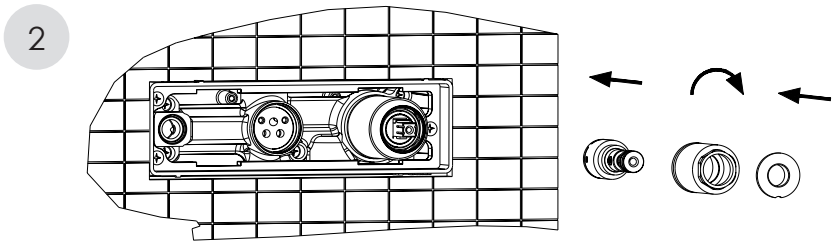
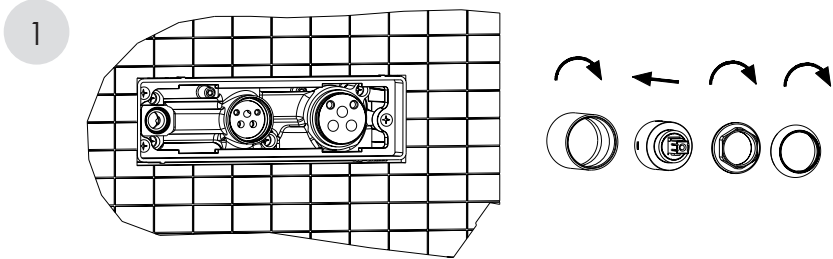

INSTALLAZIONE ESTETICHE VASCA INCASSO

Installation

Installation

Montaje

Einbau

5

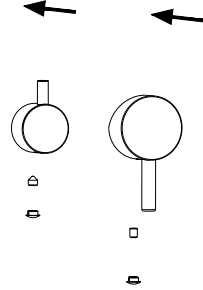
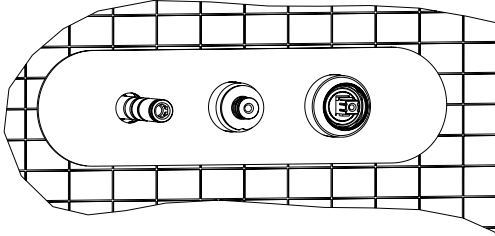

6

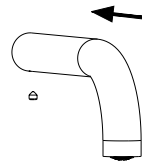
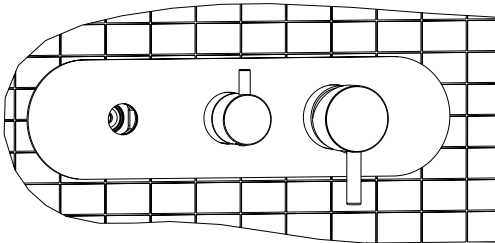

7

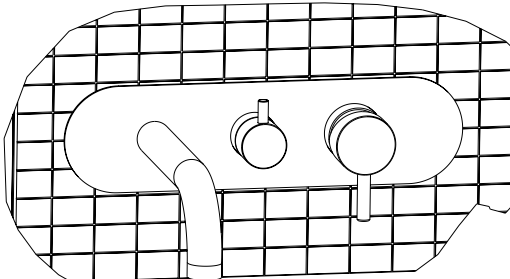

INSTALLAZIONE ESTETICHE DOCCIA INCASSO

Installation

Installation

Montaje

Einbau

1

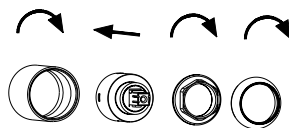
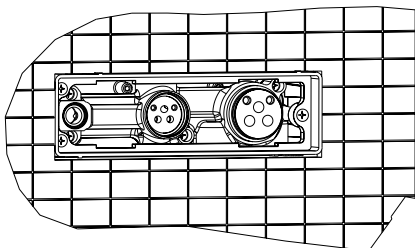

2

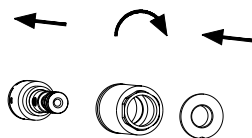
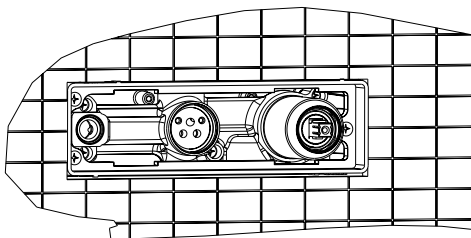

3

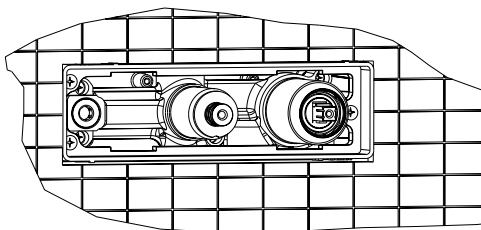

4

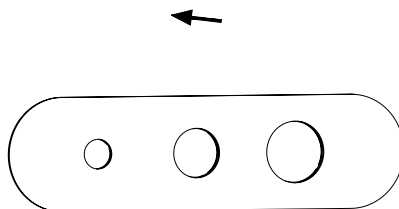
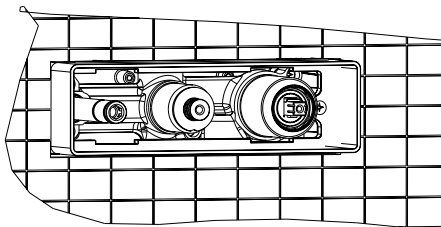

INSTALLAZIONE ESTETICHE DOCCIA INCASSO

Installation
Installation
Montaje
Einbau

5

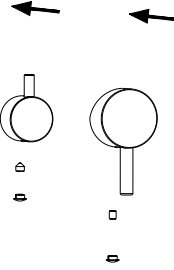
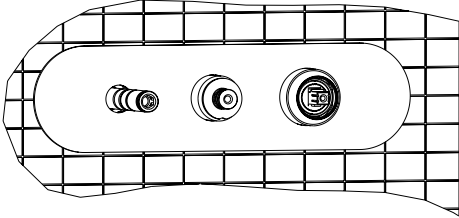

6

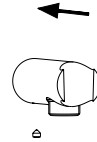
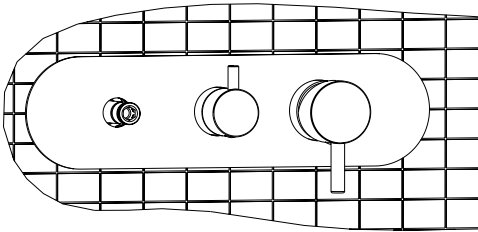

7

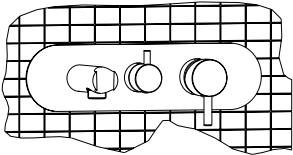

8

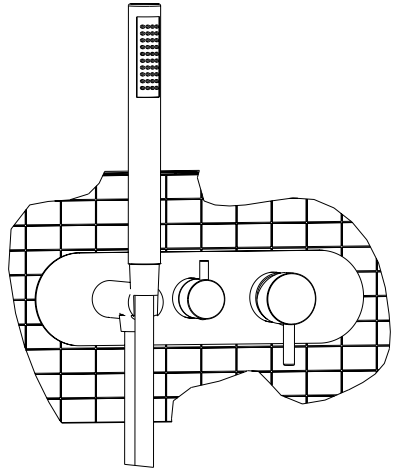















#ECOGREEN

Come smaltire gli imballaggi
How to dispose of packaging



SCATOLONE IN CARTONE ONDULATO CORRUGATED CARDBOARD BOX		CARTA PAPER
SCATOLONE IN CARTONE NON ONDULATO NON-CORRU- GATED CARDBOARD BOX		CARTA PAPER
IMBALLAGGI IN CARTA PAPER PACKAGING		CARTA PAPER
FOGLIO ISTRUZIONI INSTRUCTIONS SHEET		CARTA PAPER
SACCHETTI PLURIBALL BUBBLE WRAP BAGS		PLASTICA PLASTIC
SACCHETTI PLASTICA TRASPARENTE CLEAR PLA- STIC BAGS		PLASTICA PLASTIC
SACCHETTINI ARIA AIR CUSHIONS		PLASTICA PLASTIC
IMBALLI IN SPUGNA SPONGE PACKAGING		INDIFFERENZIATO GENERAL WASTE
NASTRO ADESIVO DUCT TAPE		INDIFFERENZIATO GENERAL WASTE
POLISTIROLO POLYSTYRENE		INDIFFERENZIATO GENERAL WASTE
SACCHETTO COTONE COT- TON BAG		INDIFFERENZIATO GENERAL WASTE
SACCHETTO TNT TNT BAG		INDIFFERENZIATO GENERAL WASTE

*verifica le disposizioni del tuo comune
*check local regulations for proper disposal

Via Roma, 125 - 28017 San Maurizio d'Opaglio (NO) ITALY
tel. 0322 96127 - fax 0322 967272
www.frattini.it - info@frattini.it

